

Technical
Drawing

Desenho
Técnico

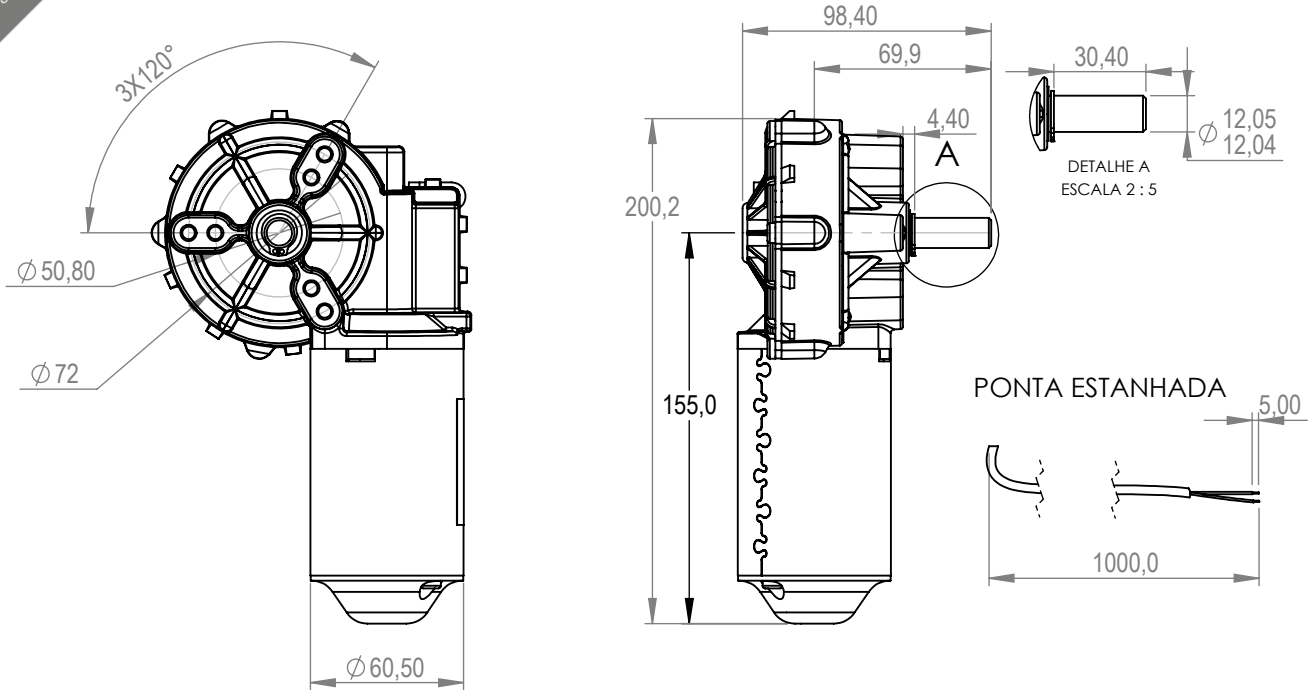

Technical
Specification

Especificação
Técnica

Imagem
Ilustrativa

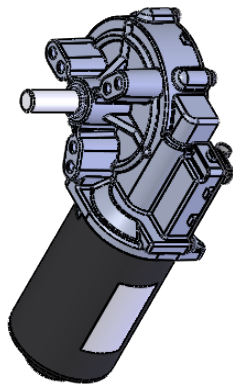

NOTAS:

Aplicação: Industrial

Application: Industrial

100503424

CARACTERÍSTICAS ELÉTRICAS	
U N (V)	27
P N (W)	56
n N (rpm)	82
I N (A)	4
I max (A)	30
M N (Nm)	6
M max (Nm)	35
I	55:1
Rotação	L / R
Peso (Kg)	1,300

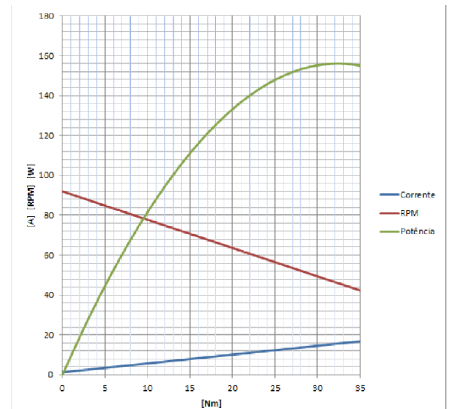

F-05